

# Estimation of In-Band Distortion in Digital Communication System

Khaled M. Gharaibeh, Kevin G. Gard and Michael B. Steer

Dept. of Electrical and Computer Engineering, North Carolina State University, Raleigh, NC 27695

Tel. 919-515-5191, FAX 919-515-2285, e-mail: {kmgharai,kggard,mbs}@ncsu.edu

**Abstract - A generalized approach for estimating in-band distortion spectrum when a wireless communication signal is processed by a nonlinear amplifier is presented. The output spectrum is represented as the sum of uncorrelated components using Gram-Schmidt orthogonalization without any restriction on the statistical properties of the input signals. The analysis allows the accurate estimation of In-band distortion and hence the effective SNR, Rho and EVM of wireless communication systems. The approach is verified by measurements of in-band distortion using feed-forward cancellation.**

## I. INTRODUCTION

Modern wireless communication systems are deploying more sophisticated modulation schemes to increase capacity and provide broadband mobile data services. Higher data rates for the same occupied bandwidth place greater signal to noise ratio (SNR) requirements for the mobile station transmitter. Transmitter SNR is a combination of independent contributions due to added thermal and device noise, nonlinear distortion, phase noise and modulator imperfections. Each independent contribution adds in power to define the transmitter noise floor. Many software tools exist for assessing the impact of thermal noise, phase noise, and modulator imperfections on SNR degradation. However, evaluation of nonlinear distortion generally requires high-level simulation because of the complex relationship between nonlinear distortion and system metrics such as SNR, EVM, and  $\rho$ .

Analysis of the impact of nonlinear distortion on SNR requires separation of the nonlinear output into components which are correlated and uncorrelated with the input signal. The correlated output contributes to the gain compression/expansion characteristic while the uncorrelated distortion contributes to SNR degradation and spectral regrowth. Nonlinear models based on power and Volterra series are not orthogonal and yield distortion components which are generally partially correlated. Recent approaches to the problem use the Gaussian approximation of communication signals [1], [2] which naturally yield orthogonal distortion components due to

This work is funded by the National Science Foundation under Grant CCR-0120319 and by the U.S. Army Research Laboratory and the U.S. Army Research Office as a Multi-disciplinary University Research Initiative on Multifunctional Adaptive Radio Radar and Sensors (MARRS) under grant number DAAD19-0101-0496.

the special statistical properties of Gaussian random processes by Bussgang theorem [3]. However, many practical signals are not accurately represented by a Gaussian signal.

We have previously presented an analysis technique to determine the uncorrelated distortion of the output of a non-linearity [4], [5]. The analysis was used to estimate system metrics such as SNR, EVM, rho and ultimately system BER. However, the analysis was limited to third order nonlinearity. In this paper we present a generalized analytical approach to the accurate estimation of in-band distortion from the output spectrum. We use the Gram-Schmidt orthogonalization procedure [6] to convert a power series model into a model with uncorrelated output components. This leads to the separation of the effective nonlinear in-band distortion and hence enables the in-band distortion and the effective system metrics to be estimated for any order of nonlinearity and without any restriction on the statistical properties of the input signal. The approach is validated by measurements of in-band distortion using feed-forward cancellation and performed on an IS-95 CDMA system.

## II. ORTHOGONAL BEHAVIORAL MODEL

Perhaps the most common and convenient way of modeling nonlinear amplifiers is to use single tone AM-AM and AM-PM measurements to extract the transfer characteristics of the amplifier. Although these basic measurements do not take the memory effects of the amplifier into consideration they result in a simple model that can be considered as a special case of the general Volterra model [7]. Therefore, and for the case in-hand, the analysis which will follow considers a memoryless nonlinearity which is characterized by an envelope (power series) model as

$$\tilde{y}(t) = \sum_{\substack{n=1 \\ n \text{ odd}}}^N \tilde{w}_n(t) = \sum_{\substack{n=1 \\ n \text{ odd}}}^N b_n |\tilde{w}(t)|^{n-1} \tilde{w}(t). \quad (1)$$

where the coefficients  $b_n$  can be obtained by polynomial fitting of the measured AM-AM and AM-PM coefficients and  $\tilde{w}(t)$  is the complex envelope of the input waveform. Power series model does not yield a representation of the output as having pure linear and distortion components because these are not orthogonal. That is, the outputs of different orders interact to produce the total output. The interaction of different orders

results in inseparable output terms and this does not allow the output components that are responsible for in-band distortion to be identified. Gram-Schmidt orthogonalization is a process by which one set of basis functions is transformed into a new set of orthogonal basis functions. Therefore, for the model in (1) the orthogonal set can be obtained as follows

$$\begin{aligned}\tilde{u}_1(t) &= \tilde{w}_1(t) \\ \tilde{u}_3(t) &= \tilde{w}_3(t) - \alpha_{31}\tilde{u}_1(t) \\ &\vdots\end{aligned}$$

where  $\alpha_{ij}$  is the correlation coefficients between the  $w_i$  and  $u_j$ . In a more general form the set of orthogonal bases can be written as

$$\tilde{u}_j(t) = \tilde{w}_j(t) - \sum_{n=1}^{j-1} \alpha_{jn}\tilde{u}_n(t)$$

where  $E$  is the expected value and  $R$  is the autocorrelation function. The correlation coefficients  $\alpha$  can be found as

$$\begin{aligned}\alpha_{jn} &= \frac{E[\tilde{w}_j(t)\tilde{u}_n^*(t)]}{E[\tilde{u}_n(t)\tilde{u}_n^*(t)]} \\ &= \frac{R_{w_j u_n}(0)}{R_{u_i u_n}(0)}.\end{aligned}\quad (2)$$

The original set  $\tilde{w}_n(t)$  can be written as a linear combination of the orthogonal set  $\tilde{u}_n(t)$  as

$$\tilde{w}_n(t) = \sum_{n=1}^j \alpha_{jn}\tilde{u}_n(t)$$

and the output is then a linear combination of the orthogonal basis functions:

$$\tilde{y}(t) = \sum_{n=1}^N b_n w_n(t) = \sum_{n=1}^N c_n u_n(t)$$

where:

$$c_n = \sum_{j=1}^N b_j \alpha_{jn}$$

is a new set of coefficients which represent the new orthogonal nonlinear model as shown in Fig. 1. Note that the new set of coefficients depends on the original envelop coefficients and the signal power level. Note also that the orthogonalization procedure is general and does not impose any restriction on the statistical properties of the input waveform (such as having Gaussian distribution).

As a result of the orthogonalization process, the output can be expressed as the sum of uncorrelated components where the cross correlation between any two components of the output is zero. Therefore, the output is expressed as a useful component  $\tilde{y}_c(t)$  correlated with the input signal, an uncorrelated distortion component  $\tilde{y}_d(t)$ :

$$\tilde{y}(t) = \tilde{y}_c(t) + \tilde{y}_d(t).\quad (3)$$

The useful part of the signal  $\tilde{y}_c(t)$  consists of the linearly amplified version of the input signal and the correlated part of the spectral regrowth term which is included in the definitions of the coefficient  $c_1$  and  $u_1$ . The correlated portion of the distortion does not contribute to distortion noise but rather affects the signal level in a manner akin to gain saturation or enhancement of discrete tones. The uncorrelated part of the output  $\tilde{y}_d$  is additive distortion noise and affects system performance in a similar way to Additive White Gaussian Noise (AWGN). Thus both the correlated and uncorrelated parts of the output affects the output SNR and BER in different ways.

The above analysis is used to derive the output autocorrelation function and hence the output PSD by which in-band distortion is estimated. The output autocorrelation function is represented as the sum of the autocorrelation functions of the corresponding terms of (3) as a result of the orthogonalization process. Therefore, using the orthogonal behavioral model, the output autocorrelation function can now be written as

$$R_{\tilde{y}\tilde{y}}(\tau) = R_{\tilde{y}_c\tilde{y}_c}(\tau) + R_{\tilde{y}_d\tilde{y}_d}(\tau)\quad (4)$$

where

$$R_{\tilde{y}_c\tilde{y}_c}(\tau) = |c_1|^2 R_{u_1 u_1}(\tau)$$

and

$$R_{\tilde{y}_d\tilde{y}_d}(\tau) = \sum_{n=3}^N |c_n|^2 R_{\tilde{u}_n \tilde{u}_n}(\tau).$$

The output PSD is obtained from the Fourier transform of (4):

$$S_{\tilde{y}\tilde{y}}(f) = S_{\tilde{y}_c\tilde{y}_c}(f) + S_{\tilde{y}_d\tilde{y}_d}(f).\quad (5)$$

The output spectrum is therefore the sum of the spectra of the uncorrelated signal components of the orthogonal behavioral model. Fig. 2 shows the output spectrum of a reverse link IS-95 CDMA signal partitioned into correlated and uncorrelated components.

### III. MEASUREMENT AND SIMULATION RESULTS

The analytical evaluation of the uncorrelated distortion component obtained from the orthogonalization procedure were verified by measurements done on IS-95 signals. Three IS-95 signals were tested; a reverse-link signal, a forward-link signal with the pilot only and a fully-loaded forward-link signal. The uncorrelated distortion spectrum was measured using a feed-forward cancellation scheme [5]. The measurements presented here were done using Agilent 8510 Vector Network Analyzer (VNA), E4438C vector signal generator, E4445A spectrum analyzer and 89600S vector signal analyzer.

Fig. 3 shows measured and simulated distortion spectra of the three signal models used and at the same input power level. The measured uncorrelated distortion spectrum was compared to simulated values using simulated spectrum and the orthogonal behavioral model. Note that the shape of the uncorrelated distortion component depends on the statistical properties of the signal and this depends on the modulation, coding and

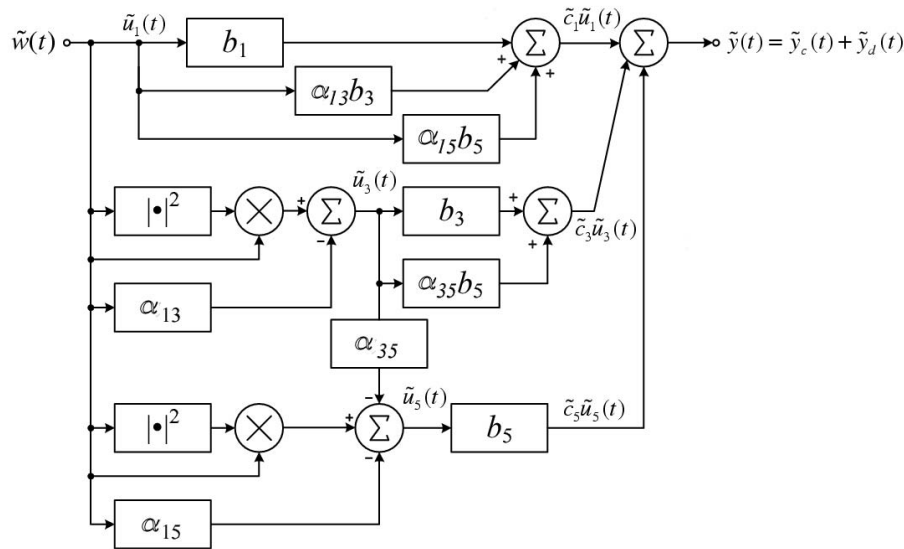

Fig. 1. Orthogonal Envelop nonlinear model with uncorrelated outputs of order 5.

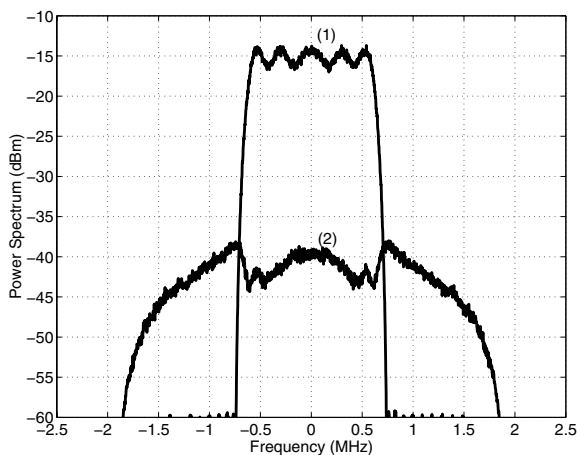

Fig. 2. Output spectrum of a reverse link IS-95 CDMA signal; (1) correlated output spectrum and (2) uncorrelated distortion spectrum.

the number of users in the composite CDMA signal. The case of fully-loaded forward link signal represents the worst case since it exhibits the highest Peak-to Average Ratio (PAR) and the shape of the uncorrelated spectrum resembles that of Gaussian signals which is flat over the bandwidth because its distribution can be approximated by a Gaussian distribution by the central limit theorem. In the case of a forward-link pilot and reverse-link signals, the uncorrelated distortion inside the main channel is below spectral regrowth in the adjacent channel. The simulated spectra show a good agreement with the measured spectra in terms of the power levels and the shape. Fig. 4 shows measured and simulated in-band distortion as a function of the output power all measured in a bandwidth of 1.2288 MHz for

the three types of IS-95 signals. The difference between the measured and simulated values at low power levels is due to the finite cancellation that the feed-forward approach provides.

#### IV. CONCLUSION

An approach for the accurate estimation of in-band distortion has been developed and verified. The approach is based on the separation of the uncorrelated distortion component from the output of a nonlinearity using Gram-Schmit orthogonalization. It has been shown that the shape and the level of the uncorrelated distortion spectrum depends on the type of signal and its statistical characteristics. The analysis presented here enables system metrics such as SNR, rho and EVM to be directly related to nonlinear distortion.

#### REFERENCES

- [1] K.Gard, L. E. Larson and M. B. Steer, "Generalized autocorrelation analysis of spectral regrowth from bandpass nonlinear circuits," *2001 IEEE MTT-S Int. Microwave Symp. Digest*, May 2001, pp. 9–12.
- [2] P. M. Lavrador, N. B. de Carvalho, J. C. Pedro, "Evaluation of signal-to-noise and distortion ratio degradation in nonlinear systems," *IEEE Trans. Microwave Theory Techn.*, Vol. 52, pp. 813–822, March 2004.
- [3] P. Banelli, "Theoretical analysis and performance of OFDM signals in nonlinear fading channels," *IEEE Trans. Wireless Comm.*, Vol. 2, pp. 284–293, March 2003.
- [4] K. M. Gharaibeh, K. Gard and M. B. Steer, "The impact of nonlinear amplification on the performance of CDMA systems," *IEEE Radio and Wireless Conference, (RAWCON)*, Atlanta, GA, Aug. 2004.
- [5] K. M. Gharaibeh, K. Gard and M. B. Steer, "Accurate estimation of digital communication system metrics — SNR, EVM and Rho in a nonlinear amplifier environment," *Automatic RF Techniques Group (ARFTG)*, Orlando, FL, Dec. 2004.
- [6] E. J. Powers, S. Im, S. B. Kim, C. H. Tseng, "Frequency-domain Volterra kernel estimation via higher-order statistical signal processing," *Asilomar Conference on Signals, Systems and Computers*, Vol. 1, Nov. 1993, pp. 446–450.
- [7] J. S. Bendat, *Nonlinear System Analysis and Identification*, John Wiley and Sons, NY 1990.

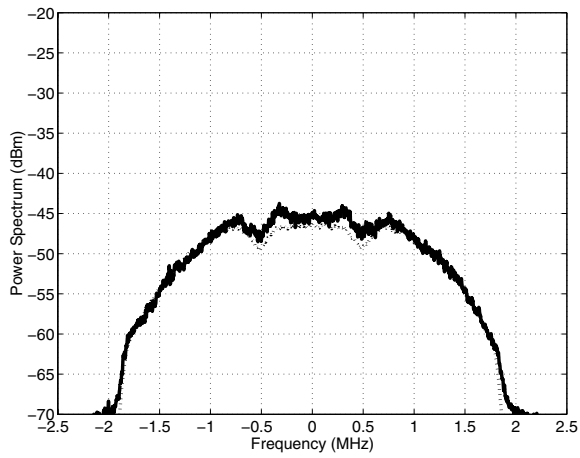

(a)

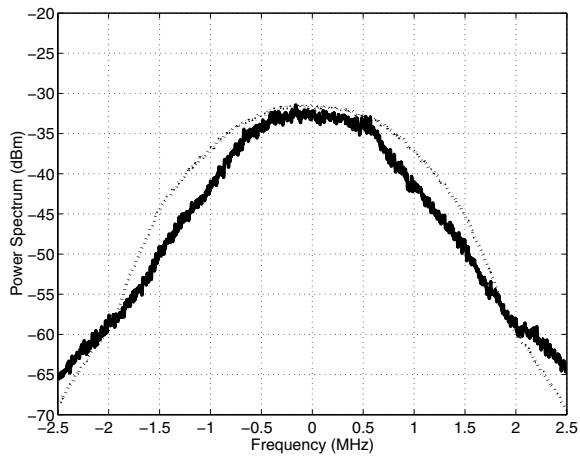

(b)

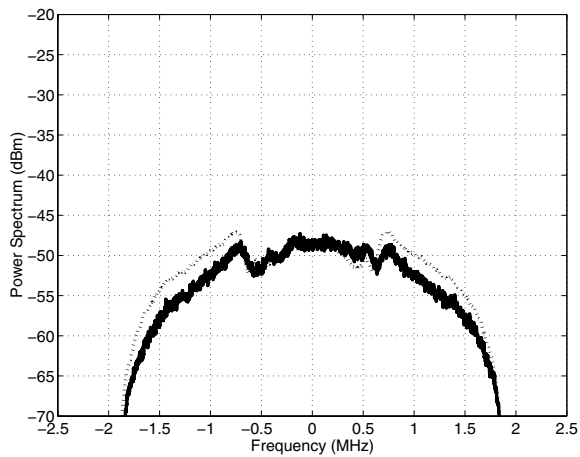

(c)

Fig. 3. Uncorrelated distortion spectrum of IS-95 signal; (a) pilot only and (b) 64 users and (c) reverse link; solid: measured; and dotted: simulated.

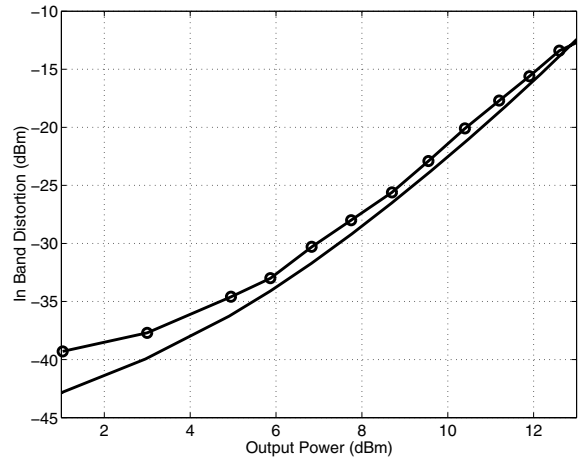

(a)

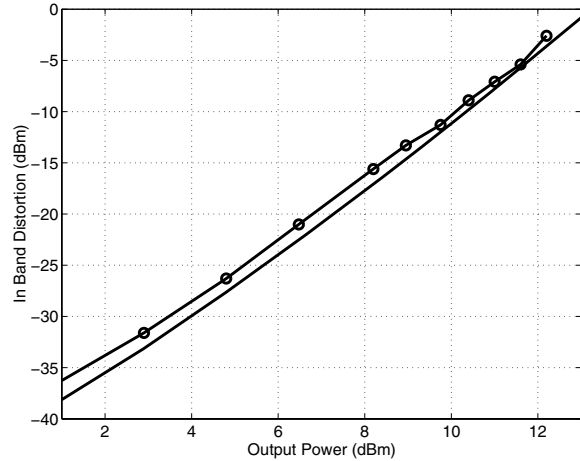

(b)

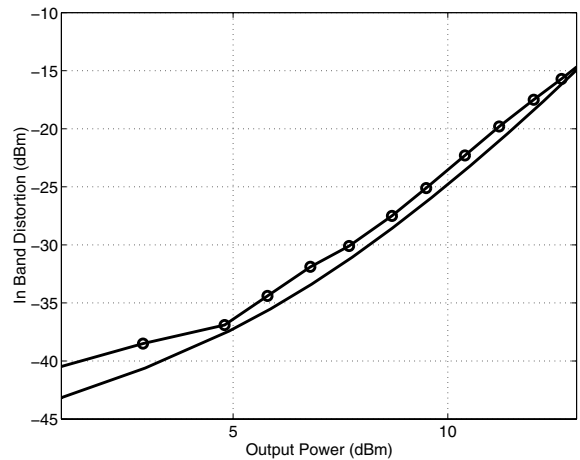

(c)

Fig. 4. In-band distortion; (a) pilot only and (b) 64 users and (c) reverse link;  $\circ$ : measured and solid: simulated.