

Multi Physics Multi Scale Modeling of Microwave Circuits and Systems Hybridizing Circuit, Electromagnetic and Thermal Modeling

Michael B. Steer¹

Abstract: Modeling of complex systems requires that a systematic approach be adopted for multi scale and multi physics modeling. The current state of physical modeling tools in the arena of microwave and electromagnetic model is considerably mature enabling discrete problems to be considered. The real need is for hybridization of discrete modeling systems to obtain a seamless simulation environment from atoms to systems. The paper explores a strategy for multi physics multi scale modeling of microwave circuits and systems. It presents a framework guiding research in the development of electromagnetic and microwave modeling tools

I. Introduction

We have reached the stage where we can entertain the design of very complex systems that involve the interaction of a variety of physical effects and that can involve millions of elements. Examples include modeling of the microprocessor chip and of spatial power combining systems. These are enormously complex systems yet we are able to design fabricate and utilize these systems. Success has been achieved using abstract models and operating a system at significant back-off from its potential. For example, a microprocessor could contain transistor elements that have ultimate switching speeds (the transistors f_T) of hundreds of gigahertz yet clock them at just a couple of gigahertz. We compensate for the uncertainties by tremendous sacrifices in ultimate achievable performance. The same back-off can be seen in nearly all other systems where it may be called a safety margin, over-engineering, gain margin, phase margin or just engineering margin. No matter what the term, the concept betrays our lack of precise understanding, fluctuations of characteristics, and design tolerances. Much higher performance would be achieved if we had a precise understanding resulting in both reduced engineering margin and engineering of systems hitherto not realized. Now we are at the point where we can envision the capture of a range of physical effects in determining performance. We are at the point where we must link the probabilistic world and deterministic worlds and must solve the problem of interfacing disparate physics and widely divergent scales.

If we could achieve precise multi physics and multi scale modeling we could reliably design systems without fabricating and characterizing individual components, and we could achieve optimization at a level of sophistication that is beyond the wildest of imaginings with our current process of technology and system development. It seems unreasonable to model every atom and electron yet the atomic level properties affect the composite performance. A systematic procedure based on multiple models at different scales, with models at adjacent scales linked to each other by defined parameterized interfaces that can be calibrated to measurement, is one reasonable approach. Thus multi scale modeling will involve very many organizations and disciplines leading to many seemingly incompatible approaches. It seems essential that an object-oriented approach be followed meaning in this context that there are well defined interfaces to models capturing a particular scale, and that the various scales are captured, most likely, by stand alone programs. Multiscale modeling is a grand scientific and engineering challenge. This paper presents a review of what is involved in modeling components of an electronic system; various strategies for modeling different types of electronic systems; and present examples of efforts that implement limited multi scale modeling strategies.

In this paper we will first consider the electronic design process. Then we will consider the integration of electronic circuits and the electromagnetic environment before considering a general long term strategy for multi physics and multi scale modeling.

¹ M.B. Steer is with the Department of Electrical and Computer Engineering, North Carolina State University, Raleigh, North Carolina, U.S.A. (email: m.b.steer@ieee.org)

tools, use Newton or quasi-Newton nonlinear solvers. These solvers are known as predictor-corrector strategies and provided that the step from one iteration to the next is sufficiently small, these can be rendered as globally convergent. It was found in the 1960's that predictor strategies alone cannot be used to analyze general circuits. In a predictor algorithm what has happened at past times or iterations is used to predict the state of the circuit at the next step. This is unstable in most cases unless a corrective iteration takes place. In the correction phase, a measure of error is utilized to improve the prediction. Thus unless the discrete time-domain field solvers evolve to use predictor-corrector algorithms they cannot be used to model any but the simplest of circuits. Even then, use of the discrete-time field solvers alone to solve device-field interactions has significant problems as in effect the linear electromagnetic environment would be solved repeatedly using an iterative nonlinear solver. Hybridization of the field solver is required in any case to handle general microwave structures, and it is this author's opinion that hybridization of the field solver with a circuit solver using the many advances in circuit simulation technology developed over the last five decades is absolutely required. One of the central cases in the development of a multi physics modeling environment is that we cannot afford to develop a single simulator to model all-things. We must develop a strategy that utilizes established modeling tools where possible and focus development efforts on interface technologies and on the tools that are compatible with hybridization. What we will describe in the following is alternative approach is to incorporate the EM environment as part of the circuit and to use a conventional circuit solver to integrate the EM and electrical effects.

One fundamental issue that arises in modeling electrically large systems in a circuit representation is that the topology of a circuit is based on nodes or terminals and these, as well as the circuits themselves have zero dimension. By the very nature of the problem being solved EM simulators are three dimensional although we can collapse the number of dimensions in some cases, e.g. with planar circuits. So an essential problem interfacing circuit and EM modeling tools is resolving the discrepancy between terminals and spatially distributed structures. This problem has been resolved by defining port connections whereby the interface a single interface between the EM environment and a circuit is two terminals (being a port) which are sufficient close together that the physical separation of the two terminals can be ignored. The next most significant problem is the assignment of system ground. Currently circuit simulators use a nodal approach in which voltages are assigned to nodes and each of these voltages is referred to a common reference point commonly called ground. In a spatially distributed system, a common reference point cannot always be defined as the (electrically significant) spatial separation of a node and its reference point cannot be tolerated. If the separation is an appreciable fraction of a wavelength, it is not possible to uniquely define voltage. Introduction of the new concept of Local Reference Terminal (LRT) and Local Reference Group (LRG) are essential extensions to circuit theory required to enable the general merging of electromagnetic models with circuit models. The concept can be illustrated with respect to Figure 3. Here a spatially distributed structure modeled using EM techniques is connected to a circuit containing linear and nonlinear elements. In Figure 3(a) a single ground is used so that at the interface between the spatially distributed structure and the conventional circuit, a cutset (A-A) is performed. Conventional circuit analysis is such that the sum of the currents crossing the cutset must be zero. However, since the reference terminal for each interface group is distinct the correct way of representing this connection is using LRTs as shown in Figure 3(b). Note that all terminals that share an LRT form an LRG of terminals. With the introduction of LRTs there are now a number of cutsets at the interface (A-A) (B-B) etc. and for each of these the sum of the currents crossing each cutset is zero. These are quite different constraints. These constraints relate directly to nodal admittance parameters which are also the basis of circuit simulation techniques. Thus the convenient way of representing the distributed circuit is by way of port-based Y-parameters. This is similar to the modeling of N-port networks where conventionally there are two terminals at each port. Now we extend the concept to multiple terminals at each port sharing a common reference terminal. Details on the impact on circuit theory are documented in [2]. One of the issues that this example illustrates is that hybridization generally requires the development of new concepts that enable supposedly disjoint techniques to be interfaced.

A spatial power combining system shown in Figure 4(a) illustrates the need for the LRG concept. Here a horn illuminates a planar array containing amplifiers located at the intersections of a grid. Horizontal

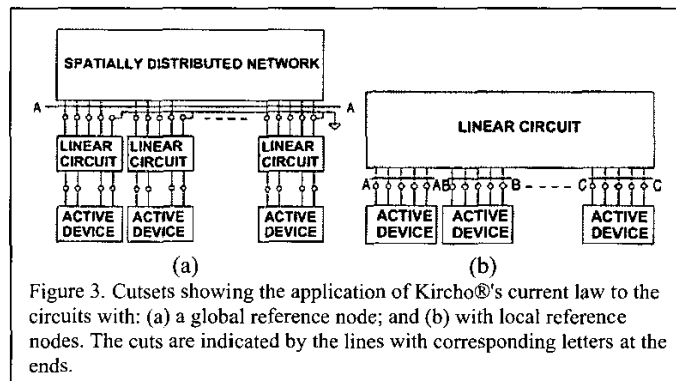

Figure 3. Cutsets showing the application of Kirchoff's current law to the circuits with: (a) a global reference node; and (b) with local reference nodes. The cuts are indicated by the lines with corresponding letters at the ends.

elements of the grid are attached to the amplifier input while vertical components of the grid are attached to the amplifier outputs. The amplified output signal is orthogonally polarized with respect to the input signal and collected by the right hand horn. Shown in Figure 4(b) are the LRGs required to model this structure with the active devices and associated linear circuitry. Detail of the Method of Moments formulation to capture the port-based Y parameters of the grid amplifier structure is shown in Figure 5. If this circuit were to be modeled with a common ground terminal located at each of the conventional circuits then this is the same as saying that there was no spatial separation of the circuitry. The circuit-oriented analysis of distributed structures using the concepts presented here can be found in a number of publications [2-7].

IV. Strategy for Multi Scale Modeling

The previous section presented one aspect of multi physics modeling, integrating circuit modeling with electro-magnetic modeling. It illustrates many of the commonalities in multi physics modeling in general. It is critically important to define the interfaces well. In this case the interface is defined by port-based admittance parameters and appropriate circuit analysis algorithms [2]. Also inherent in the circuit modeling has been multi scale modeling. Here the linkage between the phenomenological (or terminal) characteristics of the transistors are captured in device models incorporated in the circuit simulator. The link to the lower scale (at the material and transistor geometry level) has been captured by the transistor model parameters. The transistor model itself is derived through physical insight quite independently of circuit configurations. In many cases the transistor model uses geometry and material parameters but in all cases experimental verification is used to fine tune the transistor parameters. It is simply not possible to use physical modeling alone to develop sufficiently accurate models at a higher scale. This parameter calibration must also be a characteristic of multi scale modeling.

Let's step back a minute and consider the origins of microwave network analysis. Microwave computer aided engineering was born out of a strategy for multi physics modeling with the use of the circuit abstraction. Electrical engineers are so comfortable with this abstraction that few pause to realize its significance and the constraints that it imposes on modeling the physical world. One viewpoint is that a circuit — of say resistors,

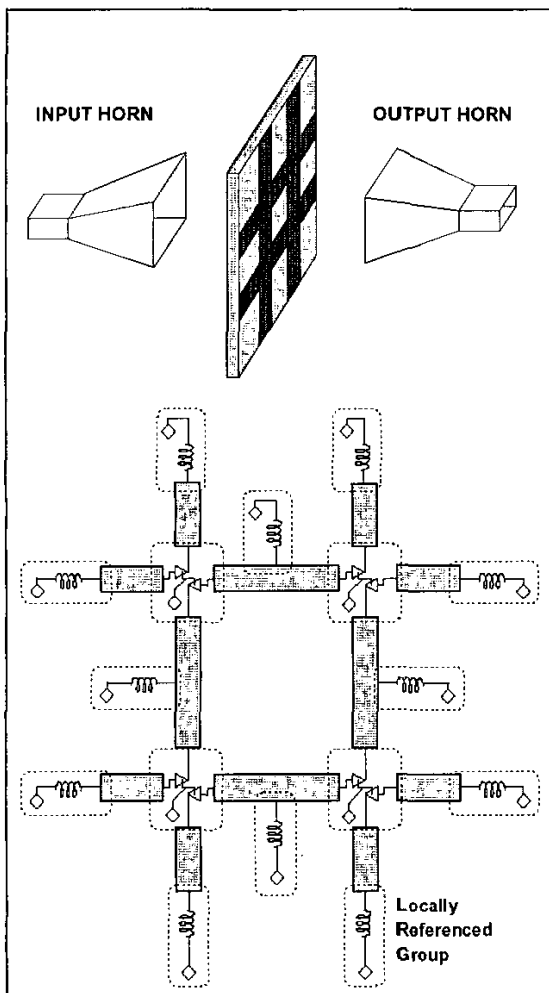

Figure 4. An active antenna array (a grid amplifier) with four differential amplifier stages located at the intersections of a 2x2 grid.

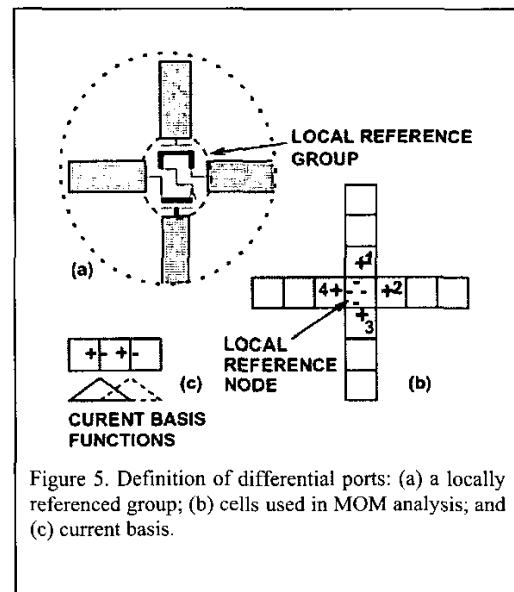

Figure 5. Definition of differential ports: (a) a locally referenced group; (b) cells used in MOM analysis; and (c) current basis.

order differential, and first order integral equations:

inductors and capacitors — is a graphical way of specifying the coupling of first order algebraic, first

$$(I = V/R), \quad (I = C \, dV/dt), \quad (I = L \int V \cdot dt)$$

At each coupling point, that is a shared terminal in circuit terms, a mathematical coupling is established using Kirchoff's current law (KCL), stating that the sum of the currents entering each node is equal to zero. There are elaborations to this procedure to accommodate more complex constitutive relations but, if at all possible, these are described by interconnections of primitives describing simpler, lower-order interactions. What we are talking about here is a dramatic expansion of the type of abstraction undertaken. In the case of the element abstractions described above characterizations of physical objects, e.g. a parallel plate capacitor is used. When it comes to multi scale modeling we are referring to modeling the material properties and coupling this with geometry to establish the model (e.g. capacitor) parameters. Microwave, and circuit engineering in general, has evolved so that transistor and circuit elements are collected to form an amplifier and other subsystems. Subsystems then become part of systems and as the scale (or abstraction level) goes higher fewer and fewer attributes are retained. Just as it would be impossible to simulate the voltages and currents of a circuit if individual electrons were considered, it is not possible to determine system parameters such as bit-error-rate by considering circuits at the system level. In the end it is the system level parameters that really matter but it is the very basic material parameters and nanometer scale structure that ultimately determine the overall performance. Some time in the near future we will be able to examine the effect on system performance by changing material parameters, say doping level, entirely using modeling. Multi scale modeling will make this possible.

The real solutions are system solutions and the maintenance of a vibrant engineering economy requires that we maintain rapid development of capability. This has traditionally been achieved through technology selection but in the foreseeable future this will be largely achieved through sensing, intelligence, multifunctionality, and adaptivity. Thus an important part of maintaining the health of the engineering profession will be supported by advances in multi scale modeling. A representation of a multi scale modeling approach is illustrated in Figure 6. Here lower scale models are closer to the physics while higher numbered scales are at increasing levels of abstraction. In going from one scale to a higher scale information must be dropped and well defined interfaces are required. It seems clear that no one organization let alone an individual will be able to cope with all of the scales. Thus an object-oriented approach must be strictly adhered to. In this context this really means well-defined interfaces but also means that there must be a minimum amount of knowledge required to traverse from one level in the hierarchy to the next. Adaptive modeling and multi scale generic modeling techniques must be adopted. Adaptive modeling must support [8-10]:

- Mathematical statement of the problem
- Formulation of model uncertainty estimators
- Uncertainty/error management, and
- Various model creation strategies.

Within each scale there can be considerable physical and heuristic knowledge but this cannot traverse scales. As such there must be compact support for a variety of multi scale modeling representations at least for the parameterized interfaces. Not many of the current modeling representations seem appropriate. Some that do include:

- Describing functions
- Power series
- Volterra series
- Multi Resolution functions (e.g. wavelets)

As an example, with respect to transistor modeling, describing functions are typically used although table-based models are also important. The describing functions (e.g. describing a transistors current-voltage relation) need only be loosely based on device physics. What is important is that the describing functions get the trends right and the coefficients of the describing function can be traced to attributes at the lower scale (e.g. geometry in the case of a transistor model). There is a major problem at lower scales as at some point probabilistic behavior must be captured in a deterministic way. We have some examples of this being done such as the representation of mobility based on Monte Carlo simulations but there is no general solution. Multi scale model development seems to be a tractable problem except for the apparent need to capture different effects in different model domain. As a result, multi resolution modeling approaches seem to be of critical importance because of their inherent compact support in different domains (with frequency and time domains being the most obvious). This is an important point; while multi resolution techniques have been important in specific application areas it has been possible to achieve solutions using alternative approaches. In EM analysis the Fixed Multipole Method can be substituted for multi resolution analysis to achieve similar or even better results

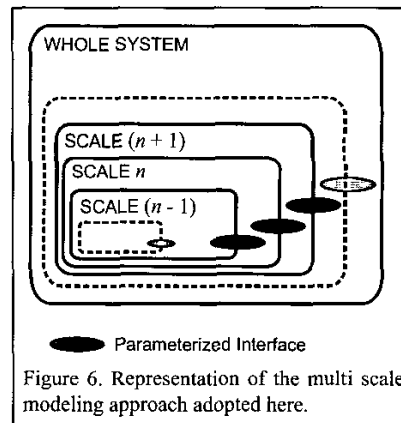

Figure 6. Representation of the multi scale modeling approach adopted here.

as less a priori knowledge about a problem is required. However in joining models at different scales multi resolution analysis seems to be unrivaled and deserves close examination.

V. Multiresolution Modeling

It is apropos to demonstrate the key concepts in the application of multi resolution representations. We will do this for a circuit application. In a circuit the circuit quantities at different terminals can be varying at vastly different rates as illustrated in Figure 7. In conventional transient analysis the basic unit of analysis is defined by the time step and the same time step is used at every terminal in the circuit. In wavelet-based transient analysis different time steps can be used in different parts of the circuit and the time step adjusted according to activity. A generic waveform is shown in Figure 8 and different parts of the waveform vary at different rates. Instead of a waveform we could consider any quantity that must be represented using basis functions. Ideally it would be possible to directly utilize the basis functions at various scales this providing the parameterized interfaces indicated in Figure 6. First we will consider a number of basis function representations.

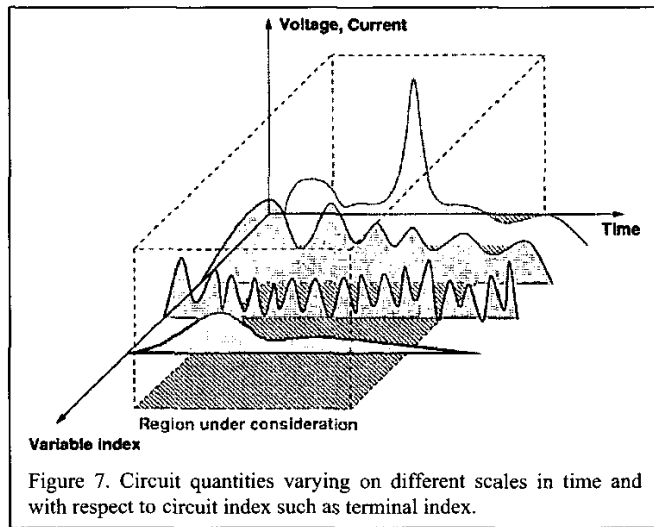
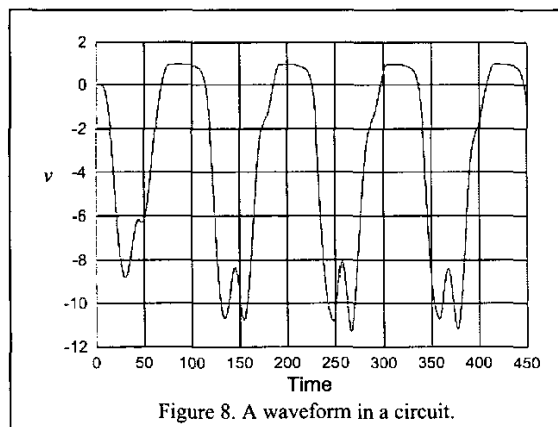

Figure 10 shows the representation of the waveform using sub domain basis functions. In a circuit simulator these would be individual time steps where the inherent representation of the basis function from one time step to the next is a trapezoid rather than a pulse. Similar sub domain representations are used in electromagnetic analysis with discrete modeling methods such as finite element or finite difference methods. This is also the representation used in the EM Method of Moments. Figure 9 presents the whole domain basis function representation. This is the EM representation used in the spectral domain representation. It is a good representation but does not capture transient (local) effects. Finally Figure 11 and Figure 12 present two views of a multi resolution representation but at different order.



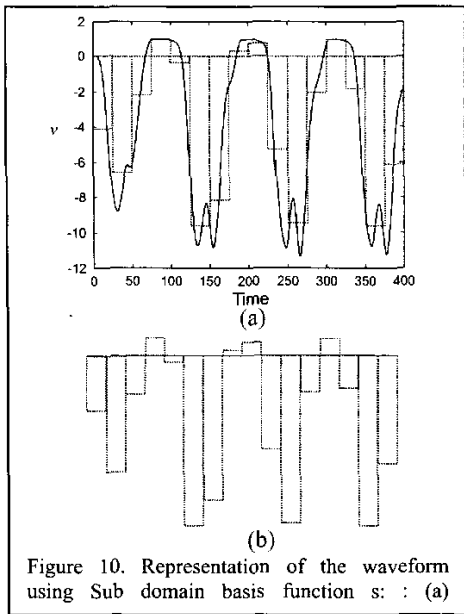

Figure 10. Representation of the waveform using Sub domain basis function s : (a)

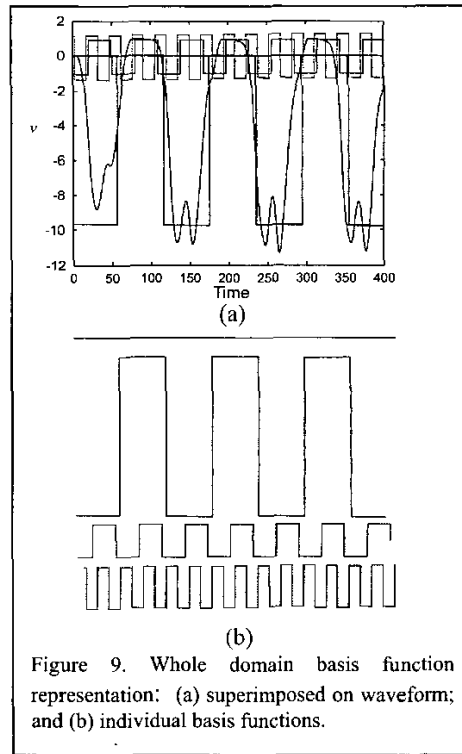

Figure 9. Whole domain basis function representation: (a) superimposed on waveform; and (b) individual basis functions.

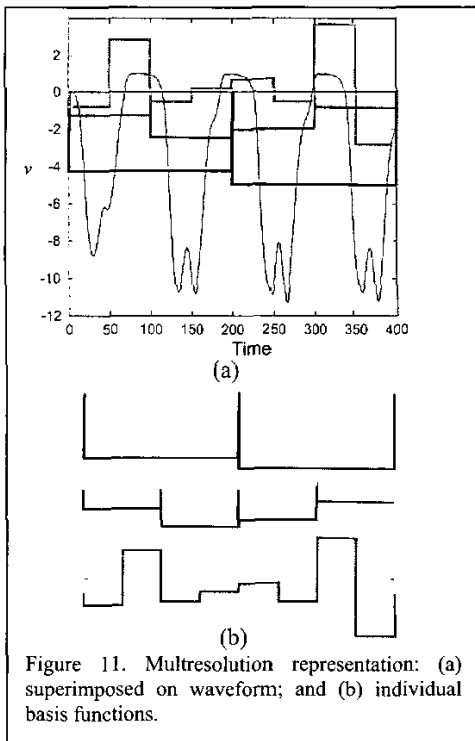

Figure 11. Multiresolution representation: (a) superimposed on waveform; and (b) individual basis functions.

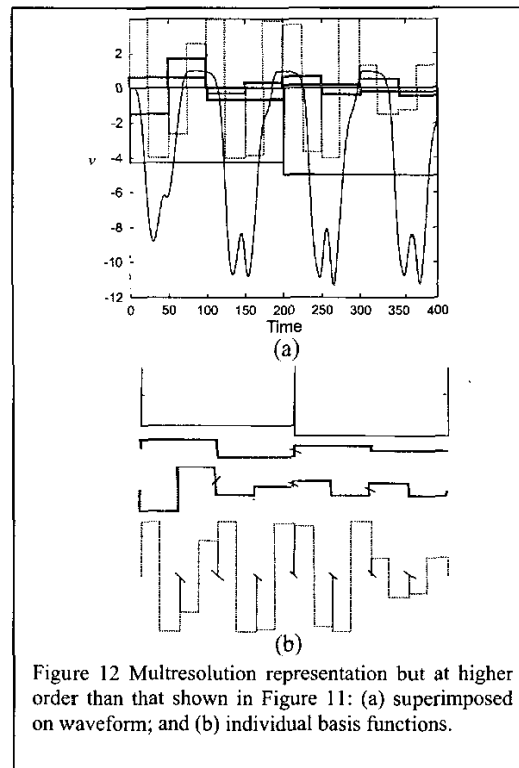

Figure 12 Multiresolution representation but at higher order than that shown in Figure 11: (a) superimposed on waveform; and (b) individual basis functions.

The multi resolution representation shown in Figure 11 has lower order functions than does the representation of Figure 12 and is easier to see what is happening. In modeling a waveform a span of time is considered. Now we are looking at just pulse functions and these do not have compact support (limited width in two or more domains) however they do illustrate the principle of multi resolution modeling. Higher order multi resolution basis functions (increasing as we move down in Figure 11 capture localized characteristics. At lower order a broad approximation of the waveform is obtained. Figure 12 just adds another order of the multi resolution basis functions. The critical aspect here is that very fine resolution can be achieved by using high order basis functions. However in the interface to a higher level modeling scale, only a few of the low order multi resolution bases need be retained. Fine resolution is required within a scale to capture fine features. As an example consider an amplifier circuit. The individual transistors comprising the amplifier have strongly nonlinear characteristics and so it is important to represent many harmonics, perhaps twenty or thirty. However at the external terminals of the amplifier, the response can be quite linear and little harmonic distortion may be evident. Thus low order resolution is needed to capture the essential response of the amplifier.

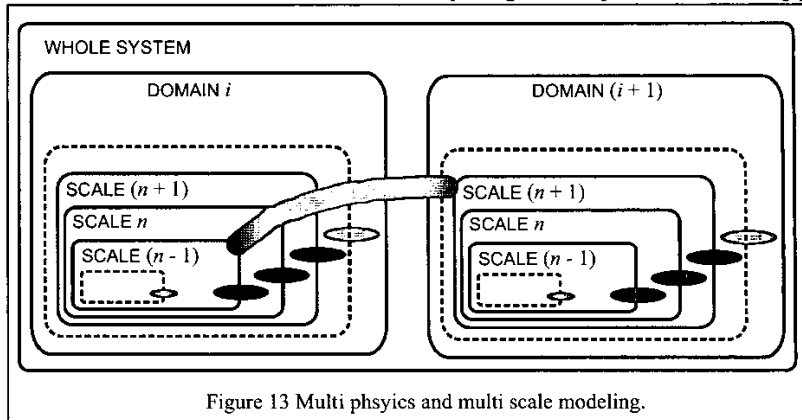

Figure 13 Multi physics and multi scale modeling.

IV. Strategy for Multi Scale Multi Physics Modeling

A strategy for combining multi physics and multi scale modeling is illustrated in Figure 13. Two domains are illustrated. These domains could be the electronic and electromagnetic domains. At the circuit level there are scales ranging from the atomic through transistor, circuit and subsystem level. At the electromagnetic level there are hybridized EM analyses. At some level in each scale the domain are linked. Between each scale in each domain are parameterized interfaces. It is unlikely that modeling can ever be undertaken in isolation and regular calibration with the actual physical world is required. Space Mapping, as illustrated in Figure 15 [11], is a strategy for enabling this calibration. It is traditionally been used for the calibration of fine and coarse models and it in the multi physics multi scale context it can be used to provide calibration of models at different scales.

An example of multi scale multi physics modeling, albeit it in a primitive form, is modeling of the spatial power combining system reported in [5] and shown in Figure 14. In a spatial power combining system the output of multiple amplifiers are combined in an EM mode to achieve large output powers. Only outline details can be provided here. Separate electromagnetic models are used for the input and output horns, planar patch

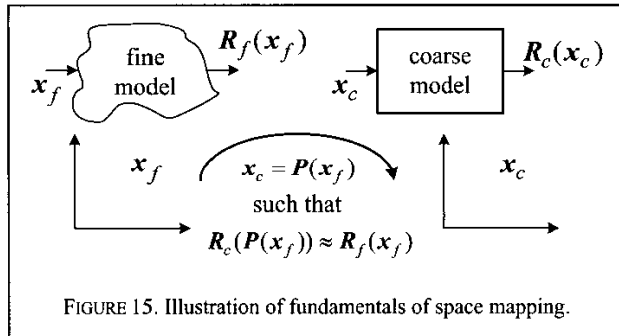

FIGURE 15. Illustration of fundamentals of space mapping.

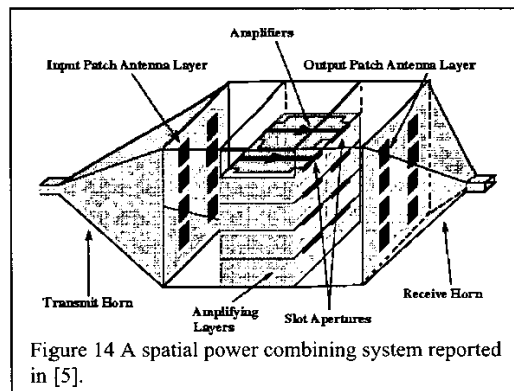

Figure 14 A spatial power combining system reported in [5].

antenna array, and of the amplifier tiles. The electromagnetic models are combined using Generalized Scattering Matrices (GSM). The complete EM model is combined with a circuit level simulator using electro-thermal transistor models yielding the modeled responses shown in Figure 16. The key issue here is that we are able to do limited multi scale and multi physics modeling.

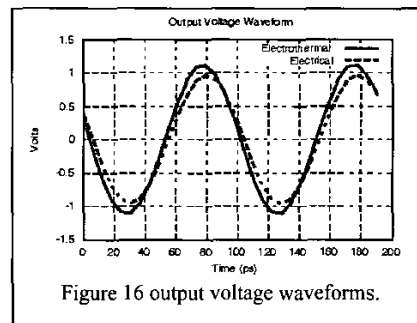

Figure 16 output voltage waveforms.

II. Conclusion

RF and microwave CAE will benefit from advances in computing power and memory, the migration to new computer architectures such as highly parallel computers, and algorithmic advances. Current analysis schemes are limited to portions of circuits and not able to handle real world excitations such as digitally modulated signals without significant simplification. In the future we must be able to model accurately real world signals and whole RF front ends with the full dynamic resolution significantly exceeding the performance expected of the actual circuit. New approaches to CAE development and to the integration of dissimilar simulation and computation techniques will be developed. We have progressed from spaghetti programming to structured programming to object-oriented programming. At the same time non-CAE specific numerical algorithms have been developed and are being incorporated in evolving CAE environments. Our views of what a circuit is (and so how it is to be modeled) have changed so we can utilize of the shelf numerics without customizing numerical algorithms to our specific requirements. Object-oriented programming is a significant paradigm shift enabling new CAE concepts to be implemented with much less effort than in the past.

References

- [1] S. M. S. Intiaz, and S. M. El-Ghazaly, "Global modeling of millimeter-wave circuits: electromagnetic simulation of amplifiers," *IEEE Trans. on Microwave Theory and Techn.*, vol. 45, Dec. 1997, pp. 2208–2217.
- [2] M. B. Steer, J. F. Harvey, J. W. Mink, M. N. Abdulla, C. E. Christoffersen, H. M. Gutierrez, P. L. Heron, C. W. Hicks, A. I. Khalil, U. A. Mughal, S. Nakazawa, T. W. Nuteson, J. Patwardhan, S. G. Skaggs, M. A. Summers, S. Wang, and A. B. Yakovlev, "Global modeling of spatially distributed microwave and millimeter-wave systems," *IEEE Trans. Microwave Theory Techn.*, vol. 47, June 1999, pp. 830–839.
- [3] M. B. Steer, J. W. Bandler and C. M. Snowden, "Computer-aided design of RF and microwave circuits and systems," *IEEE Trans. Microwave Theory Techn.*, vol. 50, Mar. 2002, pp. 996–1005.
- [4] W. Batty, C. E. Christoffersen, A. B. Yakovlev, J. F. Whitaker, M. Ozkar, S. Ortiz, A. Mortazawi, R. Reano, K. Yang, L. P. B. Katehi, C. M. Snowden and M. B. Steer, "Global coupled EM-electrical-thermal simulation and experimental validation for a spatial power combining MMIC array," *IEEE Trans. Microwave Theory and Techn.*, vol. 50, Dec. 2002, pp. 2820–2833.
- [5] C. E. Christoffersen and M. B. Steer, "State-variable-based transient circuit simulation using wavelets," *IEEE Microwave and Guided Waves Letters*, Vol. 11, April 2001, pp. 161–163.
- [6] A. I. Khalil and M. B. Steer, "Circuit theory for spatially distributed microwave circuits," *IEEE Trans. On Microwave Theory and Techn.*, vol. 46, Oct. 1998, pp. 1500–1502.
- [7] C. E. Christoffersen, S. Velu and M. B. Steer, "A universal parameterized nonlinear device model formulation for microwave circuit simulation," *2002 IEEE MTT-S Int. Microwave Symp. Dig.*, June 2002.
- [8] M. S. Shepard, M. W. Beall, R. M. O'Bara, B. E. Webster "Toward Simulation-Based Design," submitted for publication, 2003. <http://intranet.scorec.rpi.edu/reports/2003-14.pdf>
- [9] D. Datta, R. C. Picu and M. S. Shepard, "Multigrid Atomistic Continuum Method: An adaptive approach to bridge continuum with atomistic analysis", submitted for publication, 2003.
- [10] R. Wentorf, R. Collar, M. S. Shepard and J. Fish, "Automatic modeling of complex woven mesostructures", *Comp. Meth. Appl. Mech. Engng.*, vol. 172, pp. 273–291, 1999.
- [11] J. W. Bandler, R. M. Biernacki, S. H. Chen, R. H. Hemmers and K. Madsen, "Electromagnetic optimization exploiting aggressive space mapping," *IEEE Trans. Microwave Theory Tech.*, vol. 43, pp. 2874–82, Dec. 1995.